

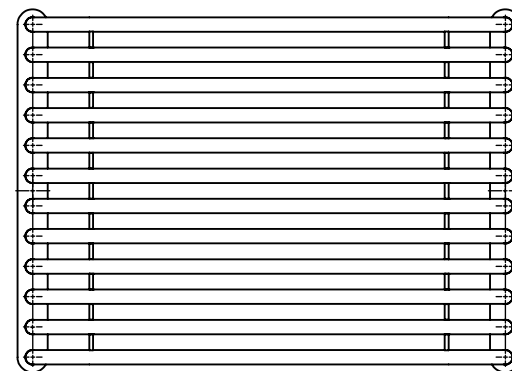

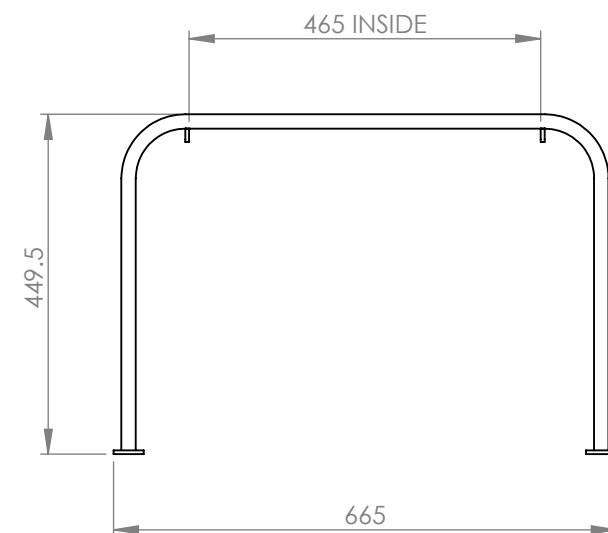

ITEM NO.	PART NUMBER	DESCRIPTION	QTY.
1	SB-MAN-ST-01A	Tubular Stool Slat	12
2	GM-TUB-BEN-02B	Stand Alone Tubular Bench Foot	2
3	GM-TUB-BEN-01C	Tubular Bench Spacer	2

APPROX WEIGHT 11 KG

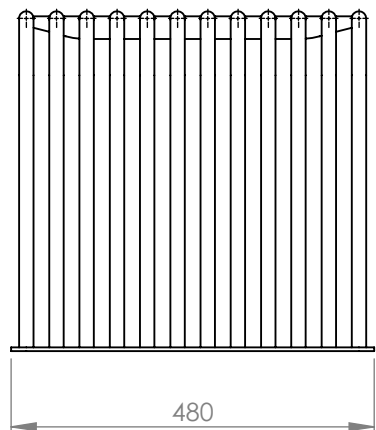
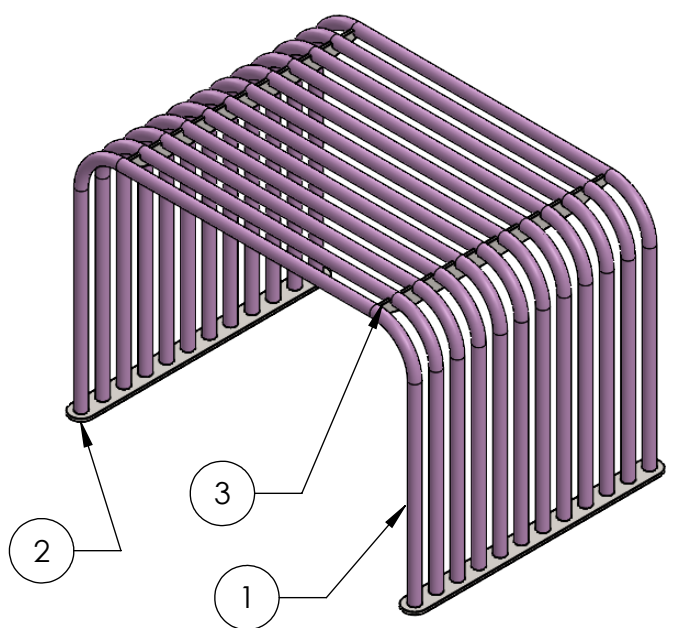

FULLY WELDED CONSTRUCTION



<p>TOLERANCES UNLESS OTHERWISE STATED.</p> <p>LINEAR: 0 - 250mm +/- 0.25mm OVER 250mm +/- 0.5mm ANGULAR: +/- 0.5deg</p>	 	TITLE:	
	<p>MATERIAL: See Parts</p>	Manhattan Stool	
	<p>FINISH:</p>	DWG/Part NO.	A4
<p>DATE</p>	<p>DRAWN Grant</p>	<p>SB-MAN-ST-01</p>	
<p>Tel: 01422 359791 Web: shawmetal.co.uk</p>	<p>DATE 02/05/2023</p>	<p>SCALE 1:10</p>	<p>SHEET 1 OF REVISION</p>